

# User Manual

## Mini Outdoor Station



## S Series Digital System Mini Outdoor Station

User Manual\_V1.0

Model No.: S0004

Model No.: S0005

# Attentions

1、 Please keep devices away from strong magnetic field , high temperature , wet environment ;



2、 Please do not fall the devices to the ground or make them get hard impact ;



3、 Please do not use wet cloth or volatile reagent to wipe the devices ;



4、 Please do not disassemble the devices.

# Content

|   |           |
|---|-----------|
| <b>Chapter 1 Product Introduction</b> .....                 | <b>1</b>  |
| <b>1.1. Function</b> .....                                  | <b>1</b>  |
| <b>1.2. Parameter</b> .....                                 | <b>2</b>  |
| <b>Chapter 2 Product Introduction</b> .....                 | <b>3</b>  |
| <b>2.1. Front View</b> .....                                | <b>3</b>  |
| <b>2.2. Back View</b> .....                                 | <b>5</b>  |
| 2.2.1. Single Lock Model .....                              | 6         |
| 2.2.2. Double Lock Model .....                              | 7         |
| <b>Chapter 3 Installation</b> .....                         | <b>9</b>  |
| <b>3.1. Installation Steps</b> .....                        | <b>9</b>  |
| <b>3.2. Installation Height</b> .....                       | <b>10</b> |
| <b>3.3. Wiring Diagrams</b> .....                           | <b>11</b> |
| 3.3.1. Single Lock Model .....                              | 11        |
| 3.3.2. Double Lock Model .....                              | 13        |
| <b>Chapter 4 Operation Instructions</b> .....               | <b>15</b> |
| <b>4.1. Calling Indoor Station/ Management Center</b> ..... | <b>15</b> |
| <b>4.2. Unlock</b> .....                                    | <b>15</b> |
| <b>4.3. Restore Factory Setting</b> .....                   | <b>16</b> |
| <b>Chapter 5 Configuration</b> .....                        | <b>17</b> |
| <b>5.1. Device Name</b> .....                               | <b>18</b> |
| <b>5.2. SIP Account Setting</b> .....                       | <b>19</b> |
| <b>5.3. Contact Setting</b> .....                           | <b>20</b> |
| 5.3.1. Call Setting .....                                   | 20        |
| 5.3.2. Contacts List .....                                  | 21        |
| <b>5.4. Card Management</b> .....                           | <b>22</b> |
| 5.4.1. Card Management .....                                | 22        |

|  |           |
|--|-----------|
| 5.4.2. Card management Setting .....             | 23        |
| <b>5.5. Unlocking Management .....</b>           | <b>24</b> |
| 5.5.1. Unlocking Records .....                   | 24        |
| 5.5.2. Unlocking Setting .....                   | 25        |
| <b>5.6. Alarm Setting .....</b>                  | <b>26</b> |
| <b>5.7. Network Setting .....</b>                | <b>27</b> |
| <b>5.8. Time Setting .....</b>                   | <b>28</b> |
| <b>5.9. Video Setting .....</b>                  | <b>29</b> |
| <b>5.10. Cloud Server Setting .....</b>          | <b>29</b> |
| <b>5.11. Community Identification Code .....</b> | <b>31</b> |
| <b>5.12. Login Password Change .....</b>         | <b>31</b> |
| <b>5.13. About .....</b>                         | <b>32</b> |

# Chapter 1 Product Introduction

This product is the mini outdoor stations of the S series Digital system VDP. By using standard CAT5 cables, it makes visual intercom call to indoor monitor and guard station possible. Besides, it supports IC access control.

## 1.1.Function

- Support SIP protocol
- Support IC card
- Support calling to indoor monitor and guard unit
- Adjustable unlock time
- Door status detection, and unlock state timeout alarm.
- Support normal open/close unlock output
- Support online update

## 1.2. Parameter

### Working Parameter

Working voltage: DC 24V/PoE 48V

Static Current:  $\leq 65\text{mA}$ /PoE 48V

Working Current:  $\leq 300\text{mA}$ /DC12~24V

Working Temperature:  $-20^{\circ}\text{C}\sim 70^{\circ}\text{C}$

Storage Temperature:  $-40^{\circ}\text{C}\sim 70^{\circ}\text{C}$

Dimension(W/H/D): 168×86×33.5mm

### Camera

Type: CMOS

Pixel: 200W

View Angle: Diagonal  $78^{\circ}$

Relative illumination: 48%

Focus Length: 2.2mm

Fill-in Light Type: white

# Chapter 2 Product Introduction

## 2.1. Front View

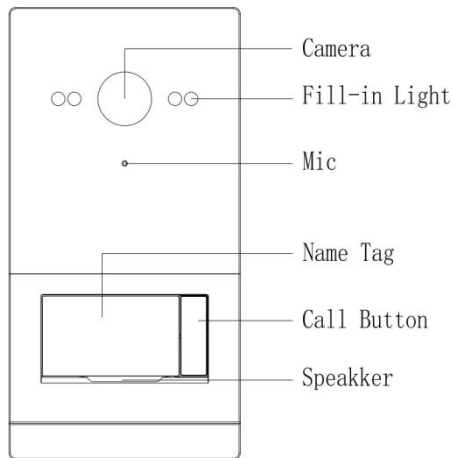
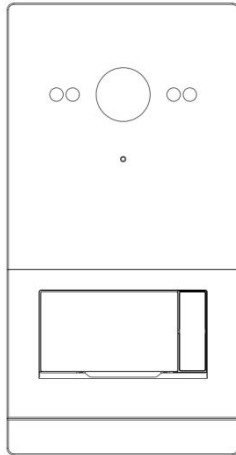

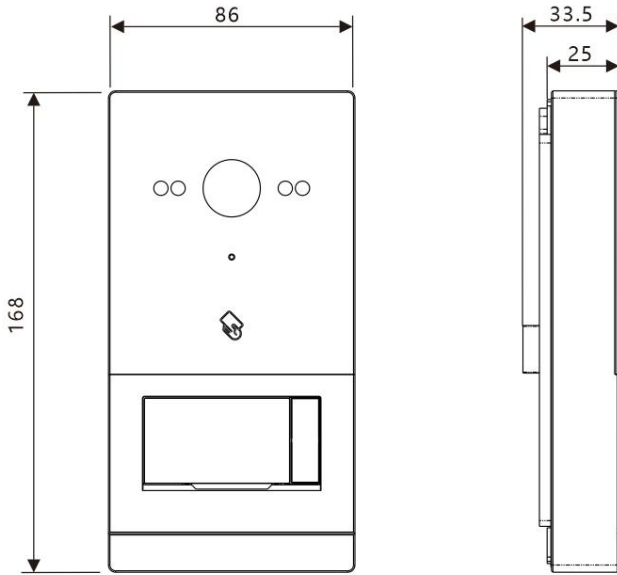

## 2.2. Back View

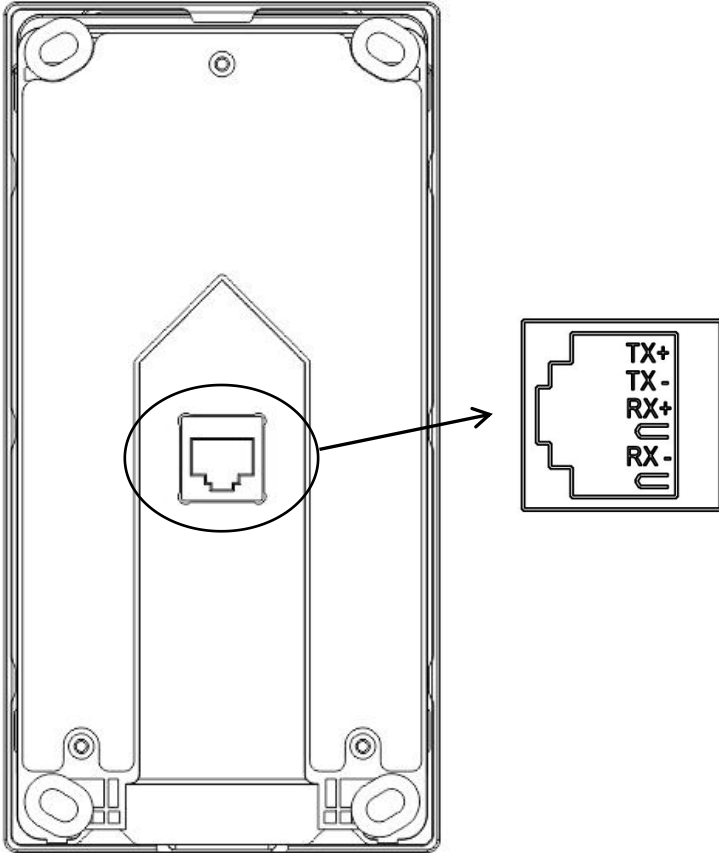

## 2.2.1. Single Lock Model

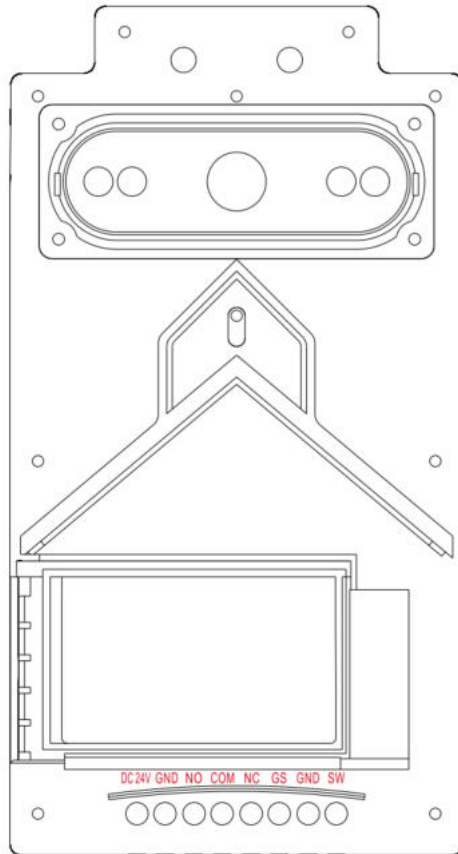

### Interface Description:

RJ45 Network Interface: cable interface, connecting standard 48V POE switch

GND +24V: independent DC 24V power supply interface

SW GND: Door inside unlock interface

GS GND: door status detection interface

NO COM NC: normal open/close interface

### 2.2.2. Double Lock Model

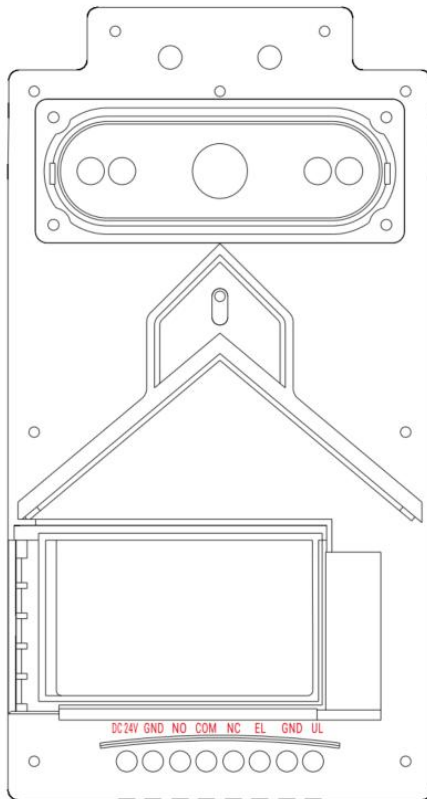

**Interface Description:**

RJ45 Network Interface: cable interface, connecting standard 48V POE switch

GND +24V: independent DC 24V power supply interface

UL GND: Door inside unlock interface

EL GND: electric control lock

NO COM NC: normal open/close interface

# Chapter 3 Installation

## 3.1. Installation Steps

Step 1: Drill holes on the wall according to the installation size (149.5×64.5mm), fix the capsules into the hole (it is recommended to align the device to the center of the reference line ), then place the device and fasten with self-tapping screws(Pic 2).

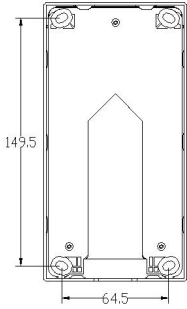

Pic 1

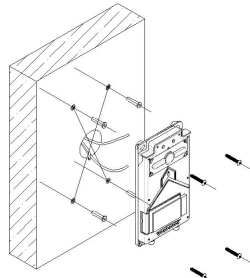

Pic 2

Step 2: Fill the paper with apartment's information, and install it in the name tag area, then complete the wiring (Pic 3).

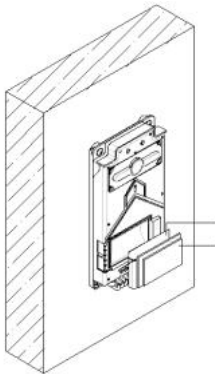

Pic 3

Step 3: Assemble the metal case onto the device, and fasten with plum blossom screw(Pic 4).

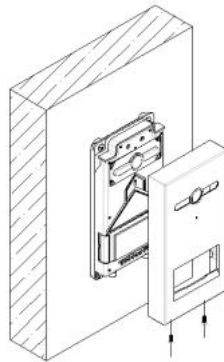

Pic 4

### 3.2. Installation Height

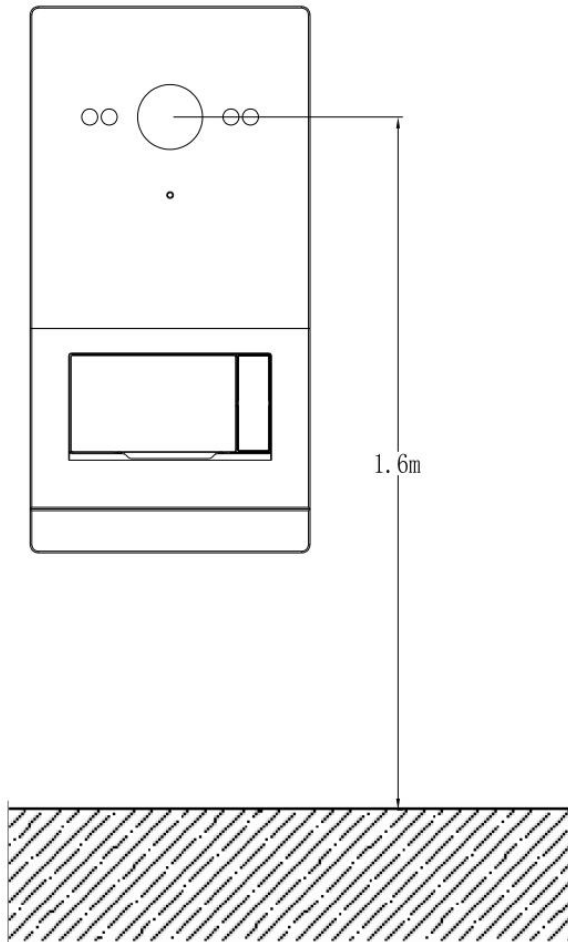

**Recommended Installation Height: camera is 1.6m above the ground**

### 3.3. Wiring Diagrams

#### 3.3.1. Single Lock Model

- Wiring for Signal Unlock Mode

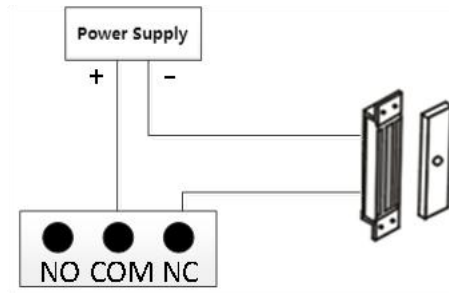

Wiring for normally closed type lock(Magnetic Lock)

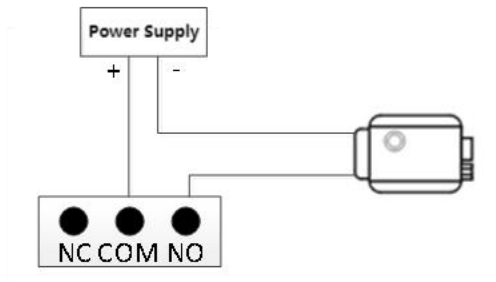

Wiring for normally open type lock(Electronic lock)

**Note:** If device is used for power supply under signal unlock mode, the device can only be powered by extra power supply. At the mean time, lock input current shall be less than 800mA, otherwise the equipment may be damaged.

- **Wiring for Exit Button Unlock Mode**

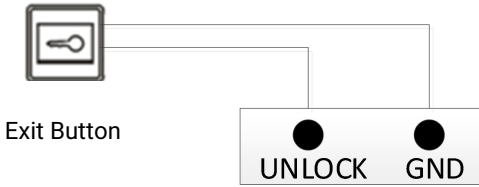

**Note:** The wiring has no polarity.

- **Wiring for Door Status Alarm**

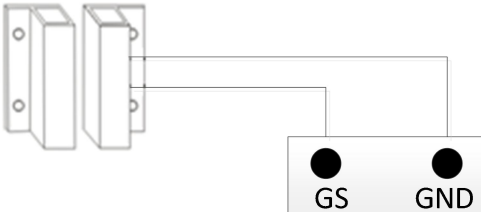

Normal Closed Type

**Note:** The door status alarm function can be switched off in two ways.

1. Grounding GS port of the host.
2. Enter “Engineering Setting->System Setting->Door Status Alarm” , turn off the door status status alarm switch

### 3.3.2. Double Lock Model

- Wiring for Signal Unlock Mode

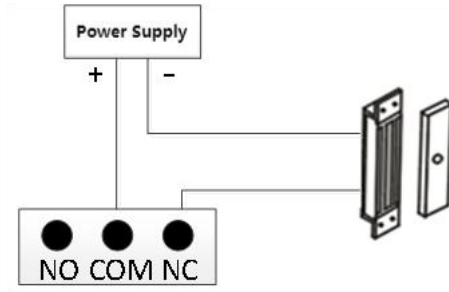

Wiring for normally closed type lock(Magnetic Lock)

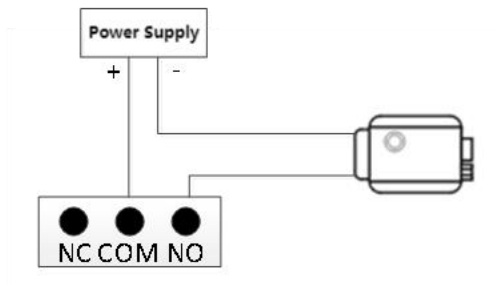

Wiring for normally open type lock(Electronic lock)

**Note:** If device is used for power supply under signal unlock mode, the device can only be powered by extra power supply. At the mean time, lock input current shall be less than 800mA, otherwise the equipment may be damaged.

- **Electrical door lock wiring**

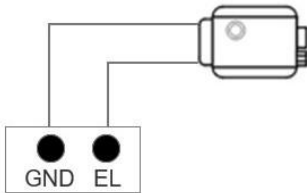

Electric door lock connection (12V)

**Note:** The wiring has no polarity.

- **Wiring for Exit Button Unlock Mode**

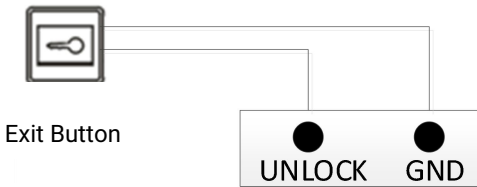

**Note:** The wiring has no polarity.

# Chapter 4 Operation Instructions

## 4.1. Calling Indoor Station/ Management Center

Prerequisite: In the configuration tool, set the called party.

The user presses the button for a long time/short time, and the mini outdoor device will call the Indoor Monitor/ Guard Unit according to the settings in the configuration tool, and ring back. If there has no answer within 30 seconds, the call will be ended automatically. During the call, the Indoor Monitor/Guard Unit can unlock the door and take screenshots.

## 4.2. Unlock

### (1) Access IC card unlock

Swipe a registered card to the card reading area of Mini Outdoor Station to unlock the door, then form the unlock record .

### (2) Indoor Monitor unlock

When a resident is called or the resident is monitoring the mini outdoor station, the indoor monitor can control the unlocking of the mini outdoor station and form the unlock record.

### (3) Unlock by Exit Button

There is an interface on the Outdoor Station that can wire to a button inside the door,

which residents inside can just press and unlock, then create the unlock record.

#### **(4) Management Center unlock**

After setting correctly in the management center, click the unlock button for all, and enter the user password to unlock the mini outdoor station, then generate an unlock record at the same time.

#### **(5) Unlock by App**

In the device list of the APP, click the nominated device to unlock, then outdoor station will generate the unlock record. To use the APP to unlock the lock, the following conditions must be met at the same time:

- a. In the configuration tool, enter the community identification code to bind the outdoor device to the community platform.
- b. The APP account is bound to the community platform and passed the personnel review.
- c. The APP account has the access control authority of mini outdoor station.

### **4.3.Restore Factory Setting**

Within 60 seconds after the device is powered on, press and hold the button for 3 seconds until you hear a "beep" sound. Release and then short press the button, and the device will automatically restore the factory settings with a long "beep".

# Chapter 5 Configuration

Operation steps of the mini outdoor station configuration tool:

1. Run the "WpfAppUpdate" program as an administrator.
2. Switch language.
3. Enter the device type as "SO004"/"SO005". Enter the Access password as "801801".  
Click "Search Equipment" to view the corresponding IP address according to the MAC address of the device.

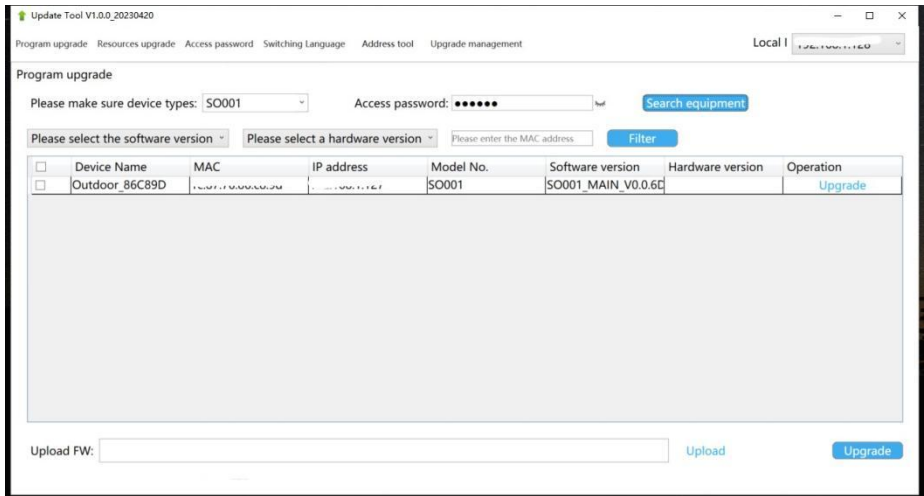

1. Enter the URL 'http://ip\_address/#/' in the browser, such as http://192.168.151.5/#/, to enter the configuration system web page of the mini outdoor station. The default password is 'admin'.

Note: Please make sure that the IP of the computer and the IP of the device to be

configured are in the same network segment.

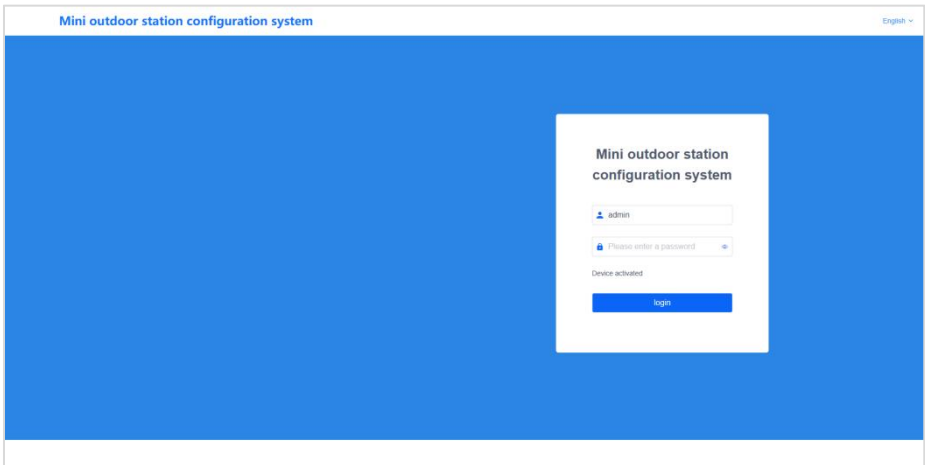

## 5.1. Device Name

The device name can be modified. If the SIP account information in the address book is required, the device name needs to be set to the device name corresponding to the account information in the address book. The device will pop up a window to prompt whether to use the account information of the address book.

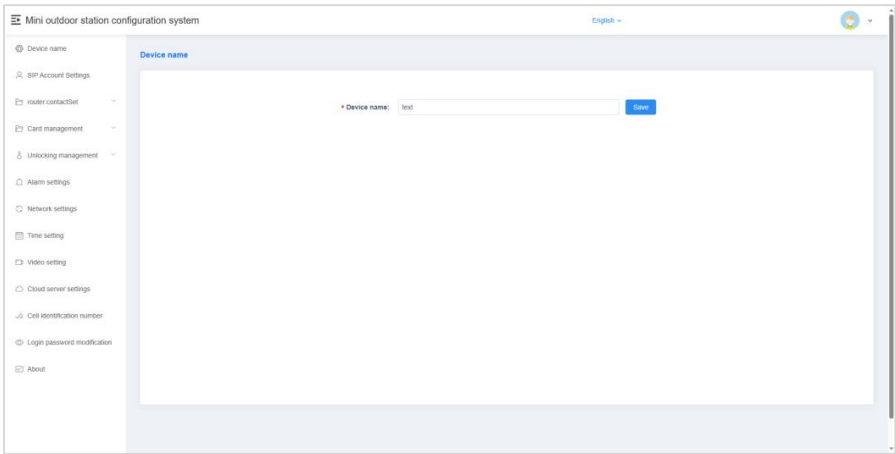

## 5.2. SIP Account Setting

- (1) Local user name: Enter user name, configure the local SIP account, for dial-up calls. Note: Cannot be duplicated with other usernames under the same network.
- (2) Local SIP account: Display the local SIP account is generated by the local user name and IP address, for call accounts under the same network.
- (3) Cloud SIP account: Display when the device is connected to the cloud server, the cloud intercom SIP account assigned by the server to the device.
- (4) SIP Account 1、2: Can manually configure SIP account information and select whether to enable it. Enter user name, server password, server address and server port, select transmission method (UDP、TLS); also can use the account information of the address book by configuring the device name.

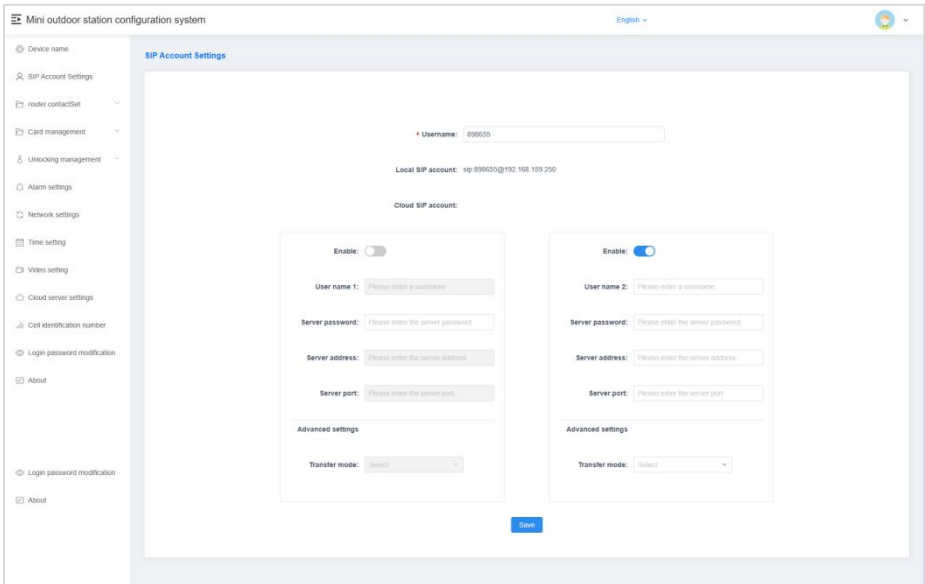

## 5.3. Contact Setting

### 5.3.1. Call Setting

Configure the called party for the button on the mini outdoor unit. Click < address book selection > button, In the pop-up window, select the contact as the short/long pressed called party, each button has a maximum of 8 contact.

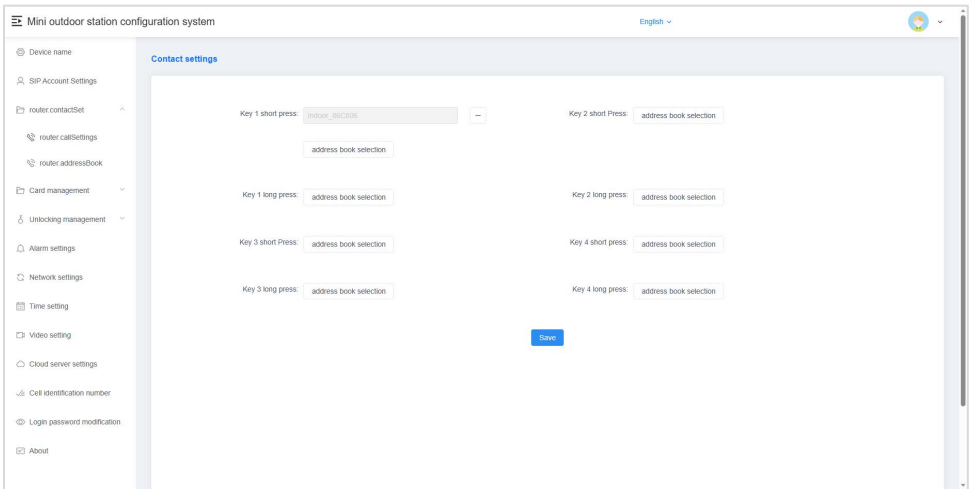

### 5.3.2. Contacts List

Display information about the current contact. Contacts include: Network devices discovered after automatic configuration is enabled、Address book Imported devices and manually added devices.

- Add: add contacts on the local device by entering the remarks and SIP account.
- Delete: can delete the contact data. Note: when the network device is online which discovered after automatic configuration is enabled, cannot be deleted. Devices imported through the address book cannot be deleted either.

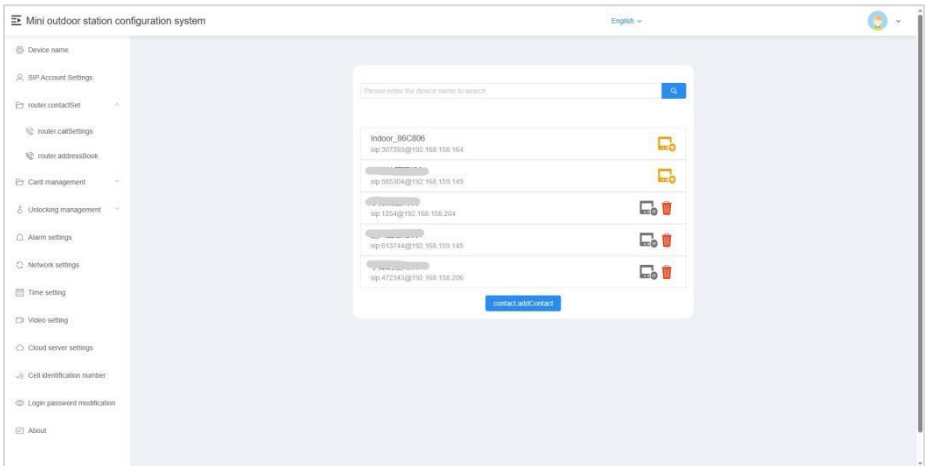

## 5.4. Card Management

### 5.4.1. Card Management

Use this configuration tool to register、modify、delete and empty the card information for local device. Under the default server or custom server mode, the local card data is automatically synchronized with the platform. The maximum storage capacity of access cards is 20,000 cards.

- (1) Single addition: Enter card numbers or put the IC card to the card reading area of mini outdoor station to read the card numbers, select card type (user card、Administrator card) , click the confirm button to add successfully.
- (2) Continuous addition: Select the card type,put the IC card to the card reading area

of mini outdoor station, hear a beep indicating successful registration, cycle swiping card registration operation.

- (3) Modification: Click the modify button in the action bar, to modify the information about access card.
- (4) Deletion: Click the delete button in the action bar, to delete the corresponding access card, and the access card will lose the unlocking permission.
- (5) Empty: Empty the data of resident cards and administrator cards of the device.

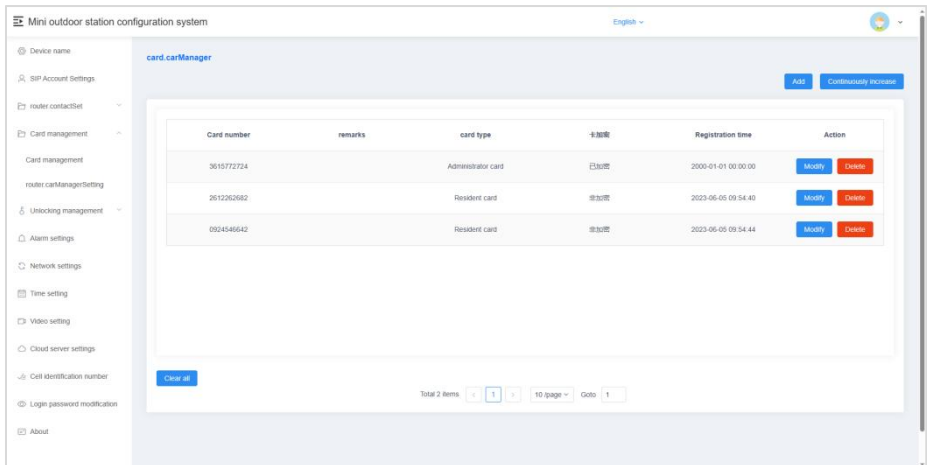

## 5.4.2. Card management Setting

Card anti-copy: When this is enabled, the registered card will be encrypted and cannot be copied.

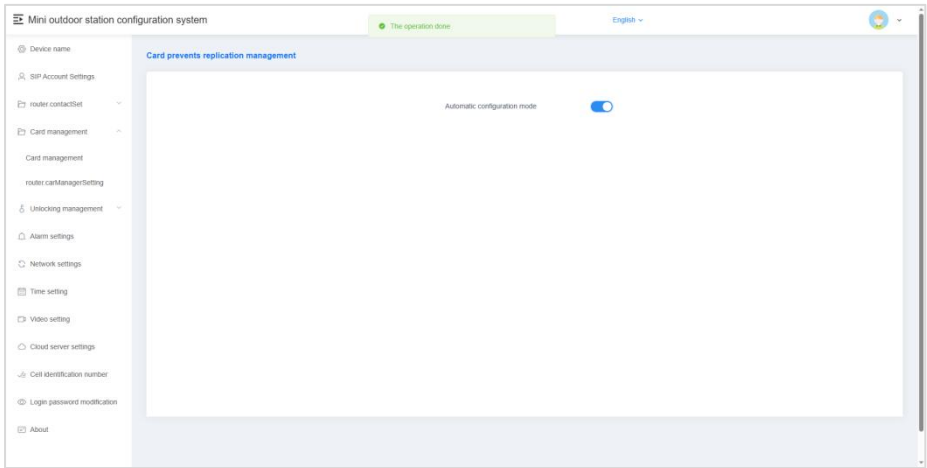

## 5.5. Unlocking Management

### 5.5.1. Unlocking Records

Used to view the unlocking record of the device.

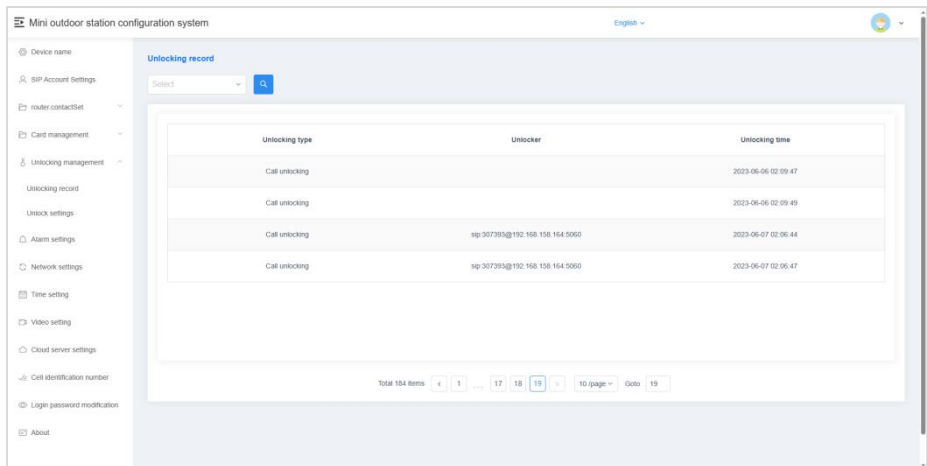

## 5.5.2. Unlocking Setting

- (1) Unlocking time: Support modify the duration of unlocking , automatically closes the door after timeout. The value ranges from 1-30 second.
- (2) Lock 1 / Lock 2 DTMF unlock password : Set the unlock password of Lock 1 / Lock 2 DTMF, Lock 1 default password is 666666, Lock 2 default password is 888888. When the DTMF password on the local device is same as the indoor unit's, outdoor station can unlock Lock 1 / Lock 2 .

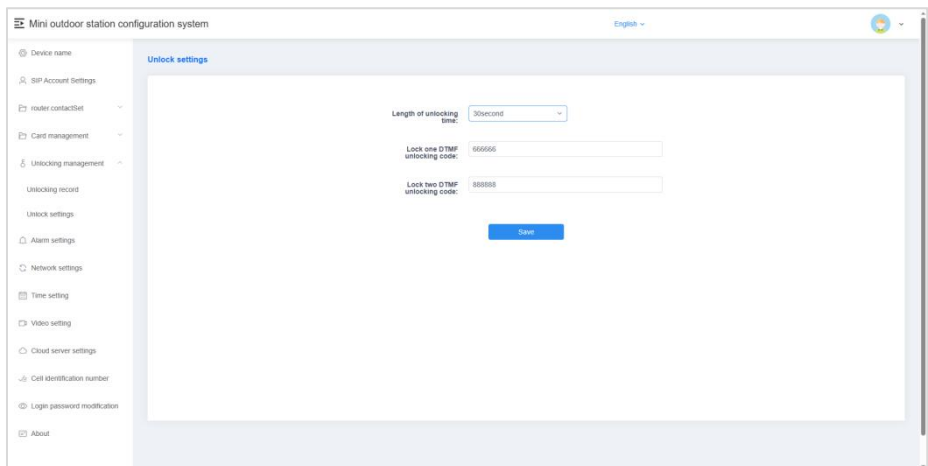

## 5.6. Alarm Setting

(1) Tamper alarm: When this is enabled, If the device is removed by external force, the device will sound an alarm tone.

(2) Disconnected alarm: When this is enabled, If the device is disconnected, the device will sound an alarm tone, and the status bar displays the disconnected icon.

(3) Door status alarm and door status alarm tone: When this is enabled, the door is detected opened over 120 seconds, the device will sound an alarm tone. Note: The double lock model does not support this feature.

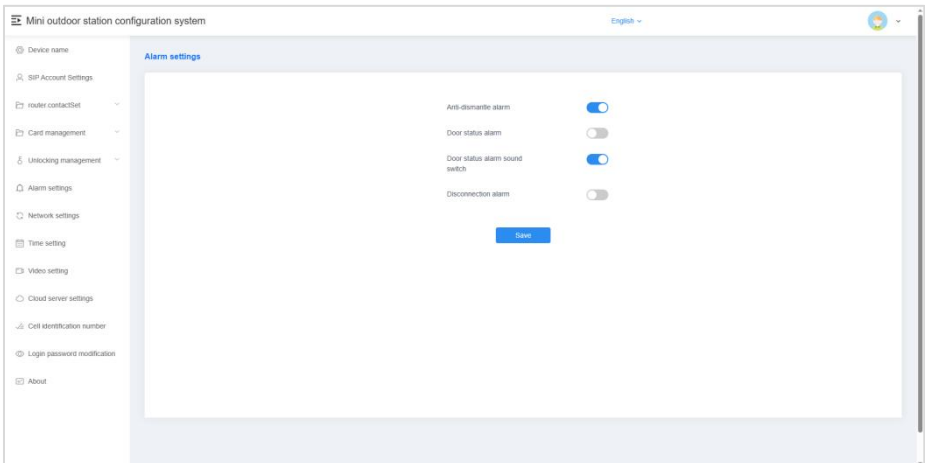

## 5.7. Network Setting

- (1) Automatic configuration mode: When this is enabled, the local device can discover other S-series devices in the same network segment.
- (2) DHCP: Need manually configure the network after closed, enter IP address、 subnet mask、 gateway、 DNS .

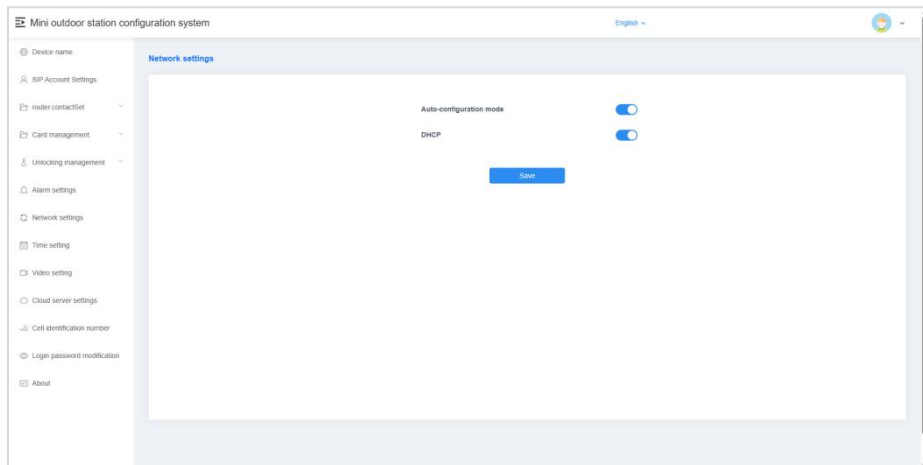

## 5.8. Time Setting

- (1) Refresh: The local time can be refreshed. After the NTP server and time zone are modified, need to click save, then click refresh, the device can get the updated time.
- (2) NTP server setup: Enter server address, enable the device to obtain the accurate clock time from the NTP server address set.
- (3) Time zone setting: According to the country, select the time zone. This machine will convert the local time according to the set NTP server and time zone.

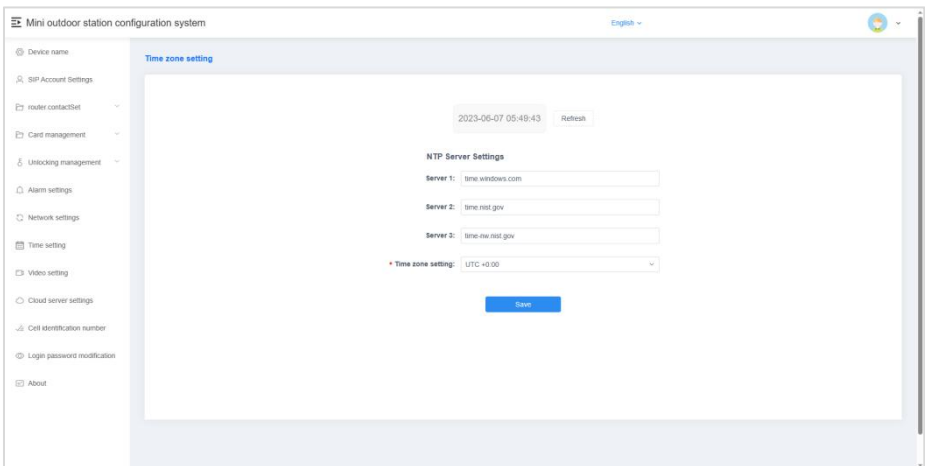

## 5.9. Video Setting

Support to set the video bit rate during the call and monitoring.

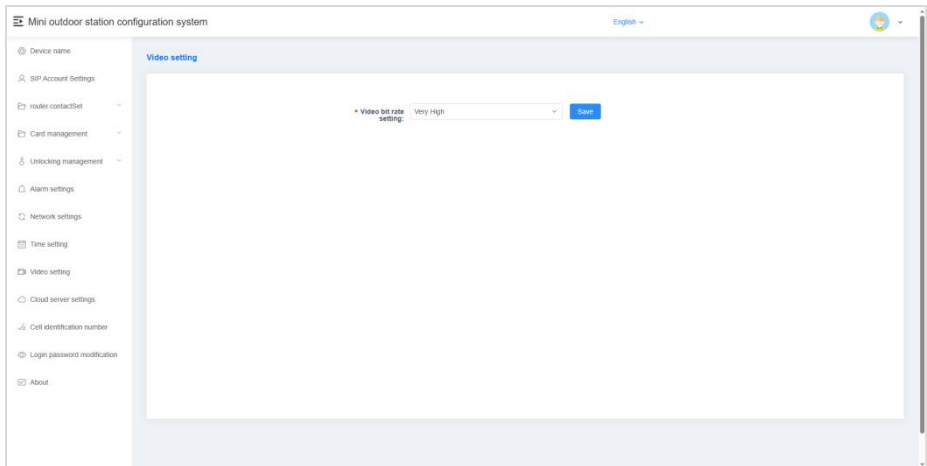

## 5.10. Cloud Server Setting

(1) Default server /Custom server

Upload the registered face and access card data to the server, and synchronize the data download from the server.

When switching to no server mode, you can choose whether to retain server data. If choose to retain, the device will not clear the data sent by the server; If choose not to retain, the device will empty the data.

(2) Without server

Stand-alone mode, the face and access card data registered on the machine are saved locally.

When switching to a default server or a custom server, can select whether to upload local data. If choose upload,then upload the local data to the server and synchronize server data; If choose not upload, then empty the local data and synchronize server data.

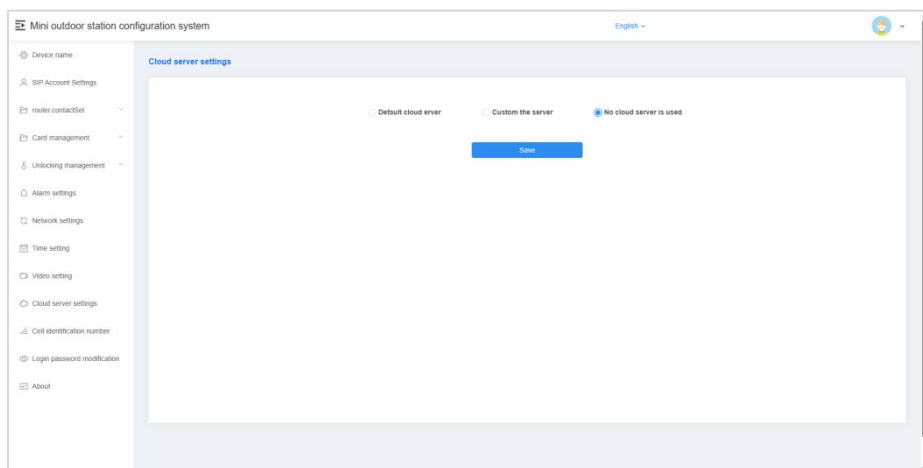

## 5.11. Community Identification Code

In default server or custom server mode, the local machine can be bound to the corresponding community by entering the community identification code.

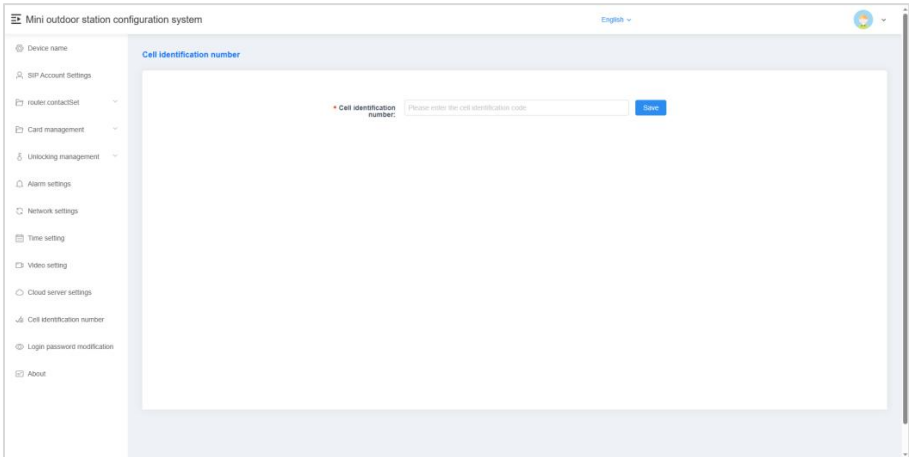

The screenshot displays the 'Mini outdoor station configuration system' interface. On the left is a navigation menu with items: Device name, SIP Account Settings, router contactSet, Card management, Unlocking management, Alarm settings, Network settings, Time setting, Video setting, Cloud server settings, Cell identification number (selected), Login password modification, and About. The main content area is titled 'Cell Identification number' and contains a form with a red asterisk icon and the label 'Cell identification number:'. Below the label is a text input field with the placeholder text 'Please enter the cell identification code' and a blue 'Done' button to its right.

## 5.12. Login Password Change

Login Password can be changed .

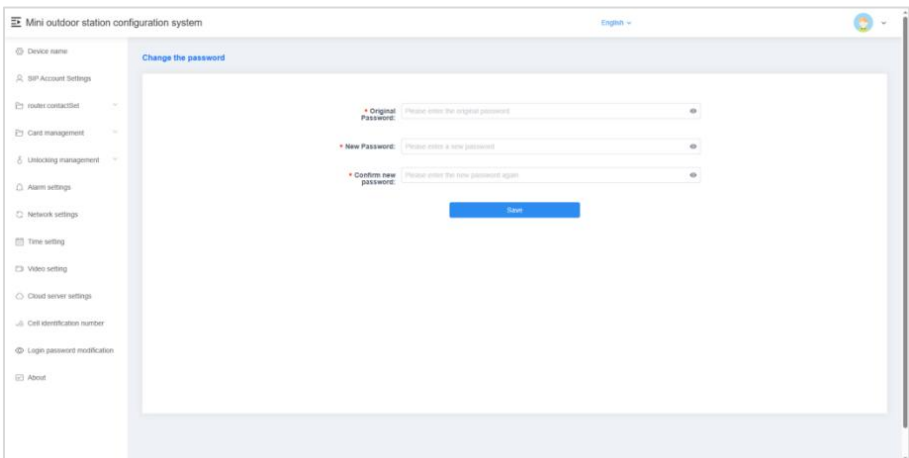

The screenshot displays the 'Mini outdoor station configuration system' interface. On the left is a navigation menu with items: Device name, SIP Account Settings, router contactSet, Card management, Unlocking management, Alarm settings, Network settings, Time setting, Video setting, Cloud server settings, Cell identification number, Login password modification (selected), and About. The main content area is titled 'Change the password' and contains a form with three red asterisk icons and labels: 'Original Password:', 'New Password:', and 'Confirm new password:'. Each label is followed by a text input field with a placeholder text: 'Please enter the original password', 'Please enter a new password', and 'Please enter the new password again'. Below the input fields is a blue 'Save' button.

## 5.13. About

Used to view device related information, including: device name, software version, MCU version, LAN, subnet mask, gateway, DNS, MAC address, cloud intercom server, device management center, and device SIP account information.

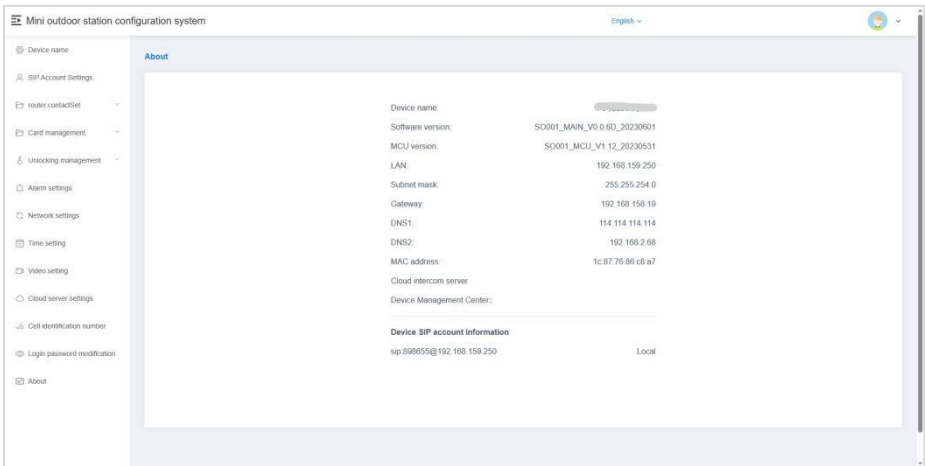

The screenshot shows the 'About' page of the Mini outdoor station configuration system. The page is titled 'About' and contains the following information:

|                           |                             |
|---------------------------|-----------------------------|
| Device name:              | [REDACTED]                  |
| Software version:         | SO001_MAIN_V0.0.60_20230601 |
| MCU version:              | SO001_MCU_V1.12_20230531    |
| LAN:                      | 192.168.159.250             |
| Subnet mask:              | 255.255.254.0               |
| Gateway:                  | 192.168.159.19              |
| DNS1:                     | 114.114.114.114             |
| DNS2:                     | 192.168.2.68                |
| MAC address:              | tc:87:76:86:c8:a7           |
| Cloud intercom server:    |                             |
| Device Management Center: |                             |

**Device SIP account information**

|                           |       |
|---------------------------|-------|
| sip:89655@192.168.159.250 | Local |
|---------------------------|-------|